

## TECHNICAL DATA SHEET

MODEL NO.	AMPS	HP	kW	NET WT.		VOLT	FREQ.
				lbs.	kg		
87R-4B-JEEAA	2.5	1/2	0.37	40	18	230	50

**NOTES:**

1. SYSTEM CONFORMS TO CE REQUIREMENTS.
2. PRESSURE SWITCH SET TO CUT-IN AT 6 BAR & CUT-OUT AT 8 BAR.
3. PRODUCT PERFORMANCE MAY VARY ±10% IN STANDARD PRODUCTION.
4. SUPPLIED WITH CEE 7/7 EURO PLUG AND ADAPTOR FOR GREAT BRITAIN/HONG KONG.
5. TECHNICAL DATA SUBJECT TO CHANGE WITHOUT NOTICE.
6. ALL DIMENSIONS ARE FOR REFERENCE ONLY.

**SOUND LEVEL** 61 dB(A) /1m

**NORMAL AMBIENT** 5-40 °C / 40-104 °F

**RELATIVE HUMIDITY** 20-80% NON CONDENSING

**ENVIRONMENT** CLEAN / DUST FREE

**PRODUCT PERFORMANCE:**

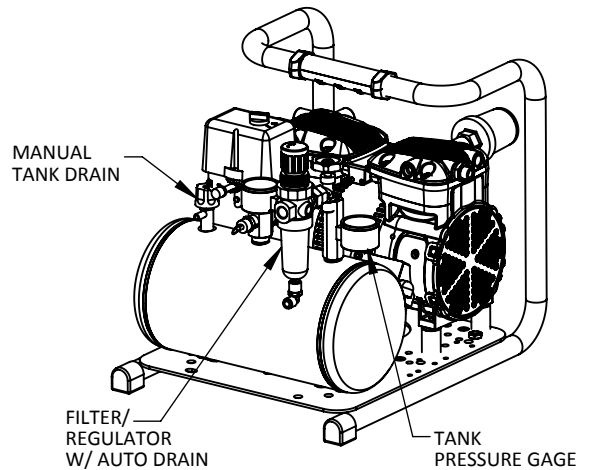
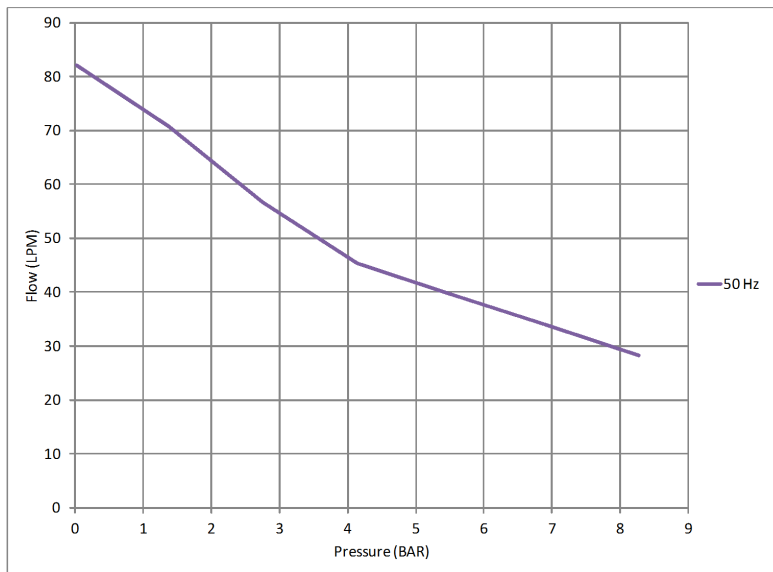

**PRODUCT DIMENSIONS:**

